

User Manual



K40960 - K40965

Wi-Fi video doorbell

Wi-Fi video doorbell

“Smart” video door entry outdoor station for calls towards connected Apps, with the possibility of answering, locks and actuations management, audio and video storage on request or following specific events:

Functions

- Call towards the Apps installed on one or more smartphones
- sd-card support with 8GB-128GB capacity
- IEEE 802.11 b/g/n 2.4GHz Wi-Fi connectivity
- Firmware update support via OTA (Over the Air)
- Adjustable conversation volume
- Adjustable call ringtone volume
- Actuators activation (lock and relay)
- Notifications support for:
 - Motion detection
 - Human presence detection
 - Audio call
 - Tamper detection
- Manual recording of photos or videos
- Automatic recording of photos or videos and 5-second pre-roll
- IR-cut filter with infrared lighting for optimum night-time visibility
- Electronic ringtone connection support (optional)
- Voice assistants support (currently devices: Echo, Echo Show, Echo Flex, Echo dot, Echo Studio)
- Status luminous indicator
- Support for up to 3 pre-settable voice messages
- The device requires an Internet connection via an IPv4 network with DHCP server

Technical data

- DC input: 24V (use the power supply unit supplied in the kit or the rectifier 40962)
- CMOS sensor 1/3" 4MPx
- Max. video resolution: 2K (2560 x 1440) pixel
- H.264 video compression
- Digital WDR (wide dynamic image regulation)
- Dimensions: 52(l) x 133(h) x 24.5(p) mm
- To work correctly there must be a stable connections to a Wi-Fi 2.4 GHz network with DHCP server and access to the Internet
- the Wi-Fi video doorbell smart device should be placed at a distance from the router or from the Wi-Fi network extender that guarantees a "good" or "medium" signal level, according to the indications of the VIEW Door App
- Maximum distance between Wi-Fi video doorbell and additional ringtone: 100 m
- Wi-Fi frequency range: 2412-2472 MHz
- Wi-Fi transmitted power: < 100 mW (20 dBm)
- RF frequency range: 433.92 MHz
- RF transmitted power: < 10 mW (10 dBm)
- Protection rating: IP54
- Lock: max 12V – 1.1A (maintenance current duration can be set in the app; maintenance current equal to 200mA)
- Relay: max 12V – 2A (relay activation time can be set in the app, from 0.5s to 10s, in 0.5s steps)









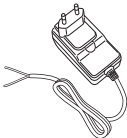

Power supply unit

Depending on the version, to power the device, the Kit includes as standard a multi-plug power supply unit or a power supply unit for DIN rail; for the technical characteristics please check the following pages.

VIEW Door App

- Available for Android system (versions from 5.1 to 12.0) and iOS (from 10.0 to 15.0)
- Receipt of calls from Wi-Fi video doorbell
- Video and audio preview from Wi-Fi video doorbell
- List of calls received function
- Consulting function via timeline
- Image and/or video saving function from calls or consultation.
- Multi-system and multi-device management function (compatible with kits K40945, K40946, K40947 and K40955, K40956, K40957)
- Lock or relay remote activation
- Setting communication time from 60s to 300s.
- Possibility of setting image resolution to three levels: HD (high resolution: 2560 x 1440 pixel); SD (medium resolution: 1280 x 720 pixel); LD (low resolution: 640 x 284 pixel).
- Requires login with a MyVimar account

Kit: Package contents

| | |
|---|---|
|  | 1 (one) Wi-Fi video doorbell complete with rear bracket |
|  | 1 (one) power supply unit (multi-plug or DIN) |
|  | 1 (one) 8GB SD-card (installed) |
|  | 2 (two) 3-pin terminals (installed) |
|  | 2 (two) mounting screws |
|  | 2 (two) wall plugs |
|  | 1 (one) spanner for anti-vandal screw |
|  | 1 (one) reset key |
|  | 1 (one) sheet of nameplate stickers |
|  | 1 (one) sheet of protective labels |
|  | 1 (one) instructions sheet |

External details

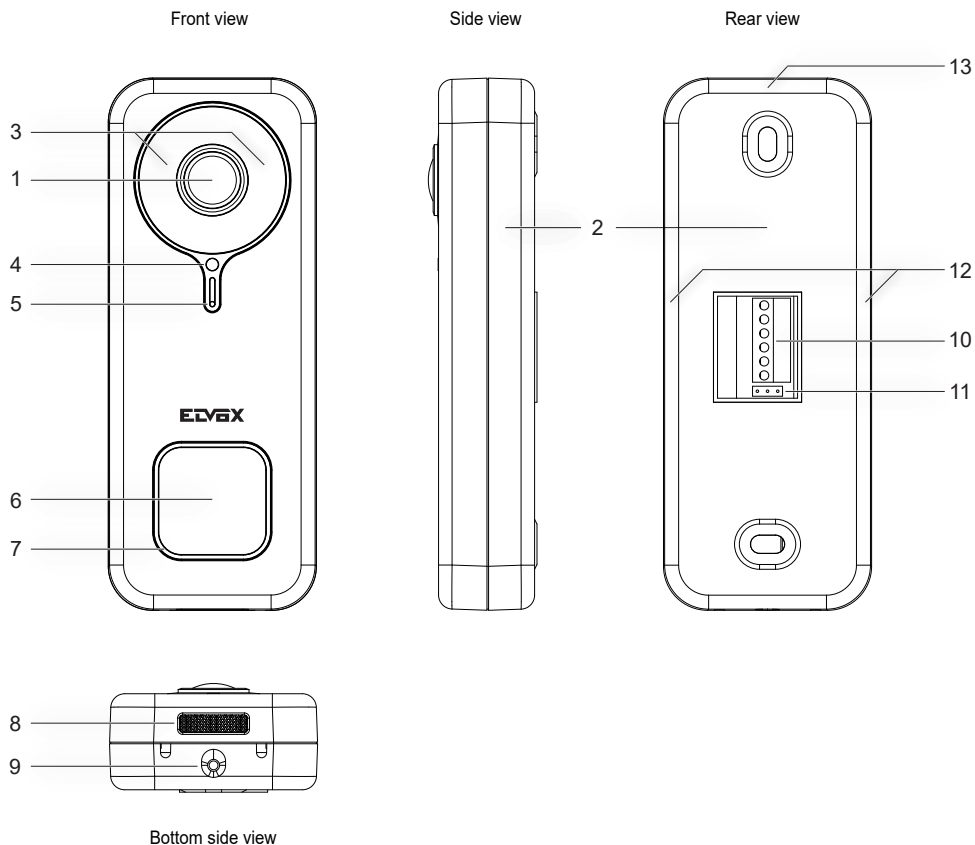

- 1 - Video sensor
- 2 - Bottom - Fixing bracket
- 3 - Infrared LED
- 4 - Brightness sensor
- 5 - Microphone
- 6 - Call button
- 7 - Status LED
- 8 - Speaker
- 9 - Anti-vandal screw
- 10 - Terminal block
- 11 - NO-NC jumper for relay
- 12 - Side anchor points
- 13 - Upper anchor point

Internal Details

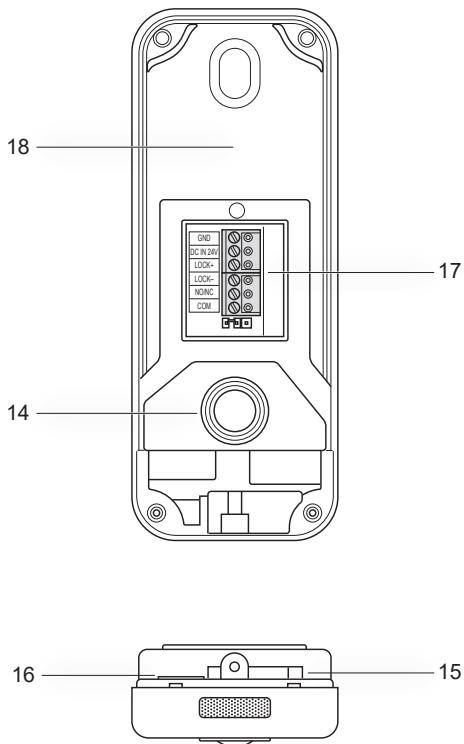

- 14 - Anti-tamper push button
- 15 - Opening for reset
- 16 - Slot for sd-card
- 17- Wiring connector
- 18 - Label with QR code

State LED

| State LED colour | State |
|-----------------------------------|--|
| Static white | S1 - device configures and connected to the cloud, in stand-by |
| Rotating white with ringback tone | S2 - call in progress |
| Rotating green | S3 - conversation in progress or firmware update in progress |
| Flashing red (3 flashes) | S4 - missed call |
| Continuous flashing red | S5 - no Wi-Fi connection |
| Flashing red with alarm tone | S6 - tamper signal (anti-tamper) |
| Static blue | S7 - device not configured |
| Rotating blue | S8 - no cloud connection |

K40960 - K40965

Connection terminal block description

| Terminal | Description |
|-----------|---------------|
| GND | Power supply |
| DC IN 24V | |
| LOCK+ | Electric lock |
| LOCK- | |
| NO/NC | Relay |
| COM | |

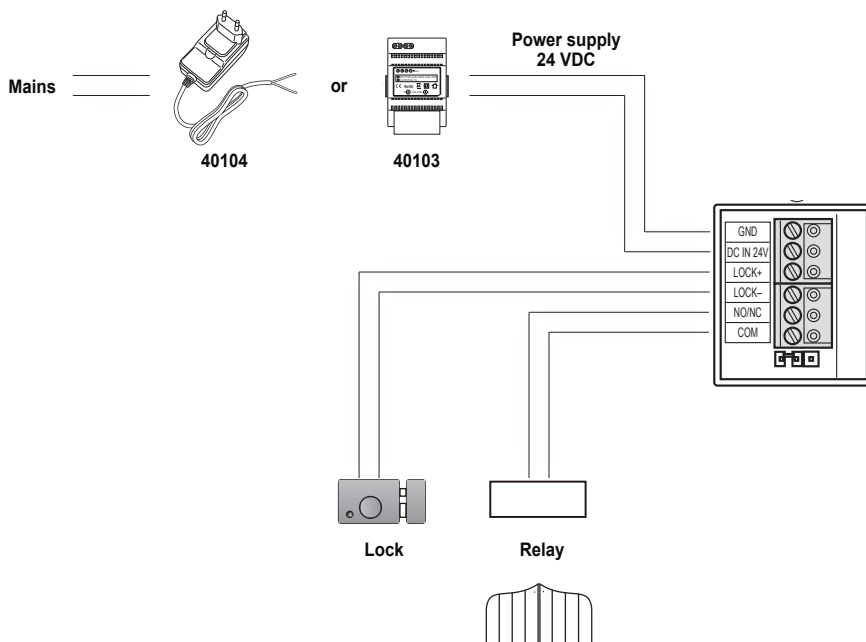

K40960 - K40965

Multi-plug power supply unit: characteristics

(for applicable versions)

- AC supply voltage: 100 V - 240 V, 0.6 A, 50 Hz / 60 Hz
- DC output: 24V, 1A
- Dimensions (mm): 43.5 (W) x 80.4(H) x 38.5 (D)
- AU / EU / UK / US plug adapters

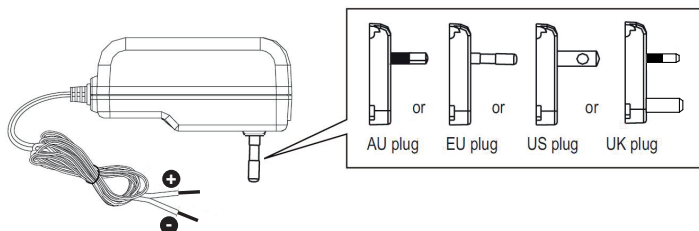

| Multi-plug power supply unit technical data | |
|---|---|
| Manufacturer | Shenzhen Fujia Appliance Co., Ltd. |
| Address | 5F of Building F, Hengchangrong (xinghui) Sci-Tech. Park, Huaning Road, Longhua District, Shenzhen, Guangdong, P.R. China |
| Model | FJ-SW2401000N |
| Input voltage | 100-240 V |
| Input frequency | 50/60 Hz |
| Output voltage | 24.0 Vd.c. |
| Output current | 1.0 A |
| Output power | 24.0 W |
| Average performance in active mode | 89.1% |
| Low-load performance (10%) | 76.3% |
| No-load power | 0.09 W |
| Regulatory Compliance | ErP Directive (EU) Regulation for external power supply units no. 2019/1782. |

K40960 - K40965

Power supply unit for DIN rail: characteristics

Technical characteristics

- Power supply: 100 - 240 VAC 50/60Hz
- Maximum power consumption 0.8 A
- Dissipated power 3.5 W
- Output voltage (+/-) 24 VDC nominal (SELV - EN60950-1).
- Max. current output: 1 A
- Operating temperature -5 °C +35 °C (indoor)
- 3 x 17.5 mm modules, dimensions: 55x91x54 mm
-  Symbol for CLASS II

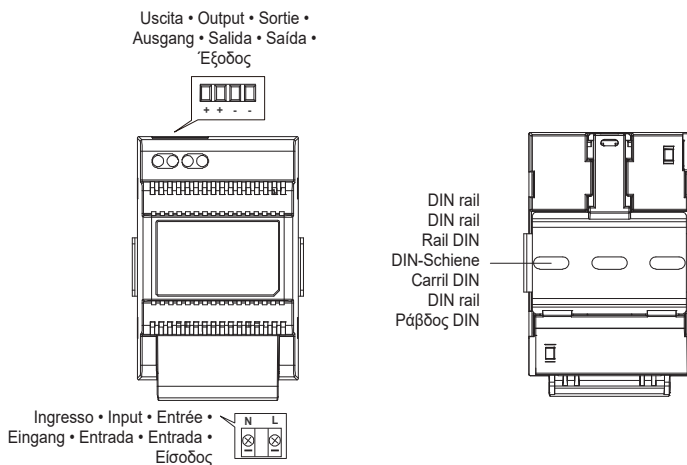

Distanza massima tra uscita DC alimentatore DIN e videocitofono • Maximum distance between DC output of DIN power supply unit and video entryphone
Distance maximale entre sortie CC alimentation DIN et portier-védo • Maximaler Abstand zwischen DC-Ausgang von DIN-Netzteil und Videohaustelefon
Distancia máxima entre salida CC alimentador DIN y videoportero • Distância máxima entre a saída DC do alimentador DIN e o videoporteiro
Μέγιστη απόσταση μεταξύ εξόδου DC τροφοδοτικού DIN και θυροτηλέφωρας

• Tipo di cavo • Type of cable • Type de câble
• Kabeltyp • Tipo de cable • Tipo de cabo
• Τύπος καλωδίου

• Lunghezza del collegamento • Connection length • Longueur de la connexion
• Anschlusslänge • Longitud de la conexión • Comprimento da ligação
• Μήκος σύνδεσης

0.75 mm²

15 m

Power supply unit for DIN rail: Possible installations

Installation on switchboard

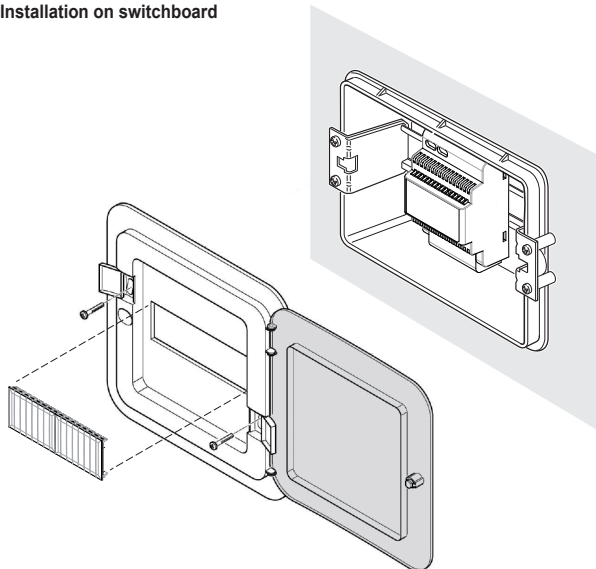

Installation on junction box

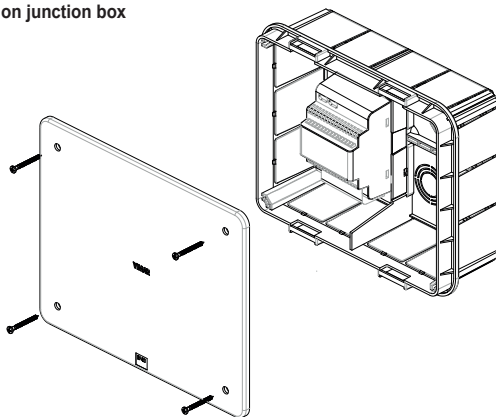

Installation

- 1) Using the key in the package, unscrew the anti-vandal screw on the bottom of the device (9).
- 2) Using a screwdriver, delicately lever along the edge of the bracket, near the side anchoring points (12): in this way, the bracket (2) is released from the Wi-Fi video doorbell body.
- 3) perform the wiring of the cables to the terminals, taking care that you observe the connection order as specific in point (17).
- 4) Screw the bracket to the wall, fixing firstly the upper hole and checking the correct vertical position, then finally the bottom hole. To correctly position the Wi-Fi video doorbell, refer to the following figure at the bottom.
- 5) To store photos and videos taken with the device, check that the SD-card is inserted in the slot indicated in point (16).

N.B.: if necessary, the sd-card should be inserted in the slot on the connectors side, with the connectors facing the front of the Wi-Fi video doorbell.

- 6) Insert the terminal block in the related male connector and power up the device: it is now possible to connect it to the VIEW Door App.

Below is the configuration procedure: we suggest you close the Wi-Fi video doorbell and tighten the closing screw only once you have correctly connected the Doorbell to the App.

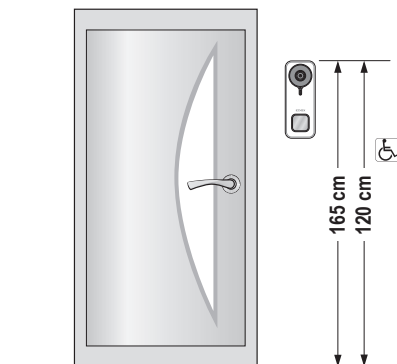

- Recommended height, unless different regulations are specified.

Opening

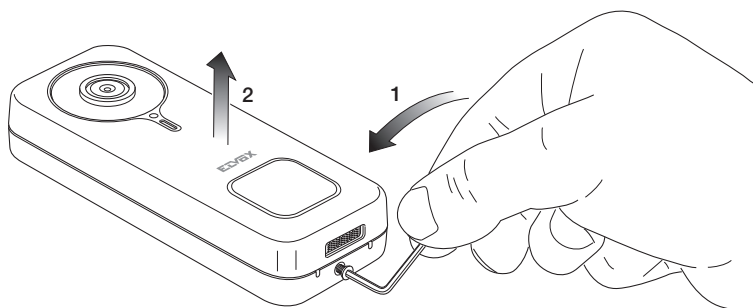

Surface mounting

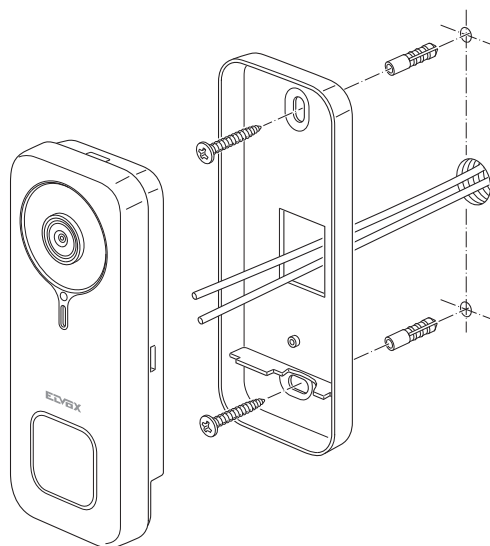

Connection by means of removable terminal block

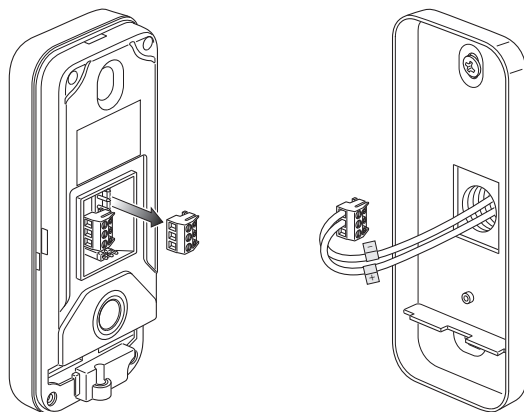

Closing

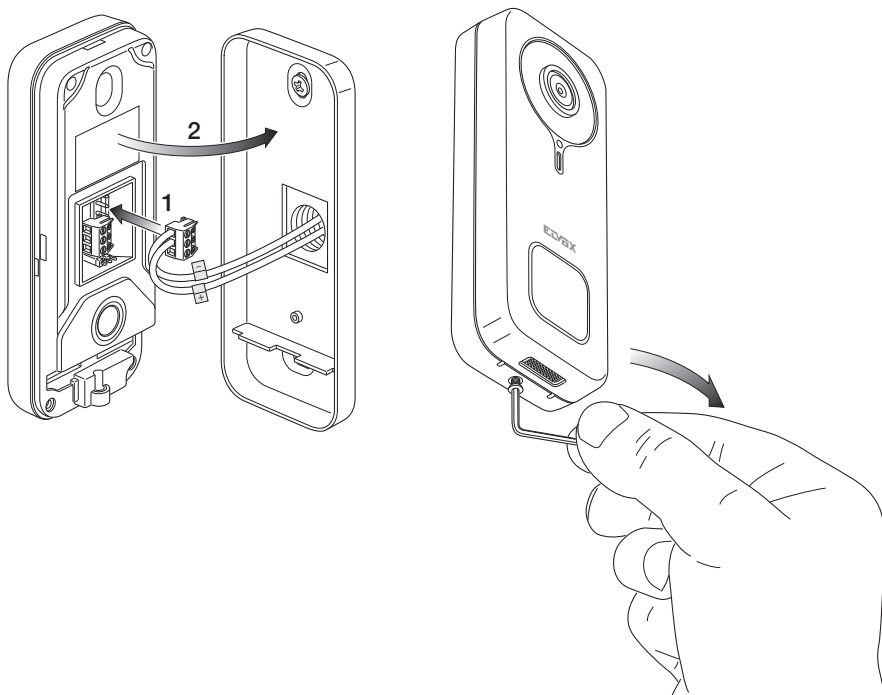

SD Card

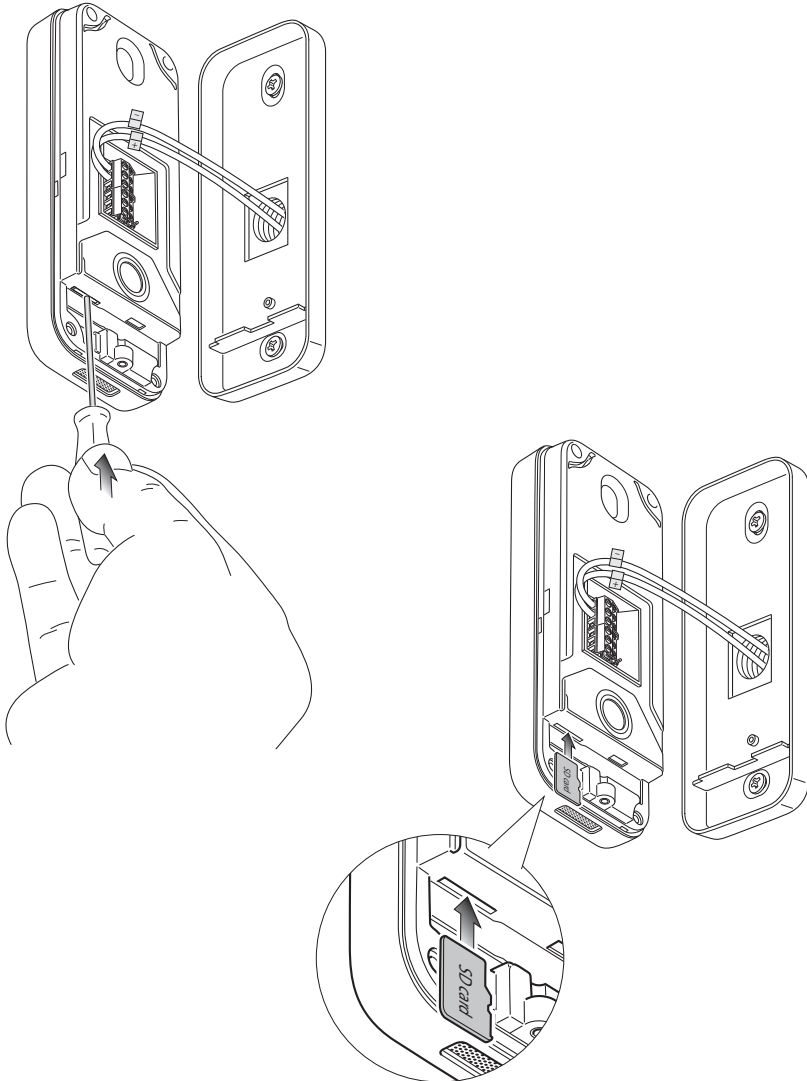

Disassembly

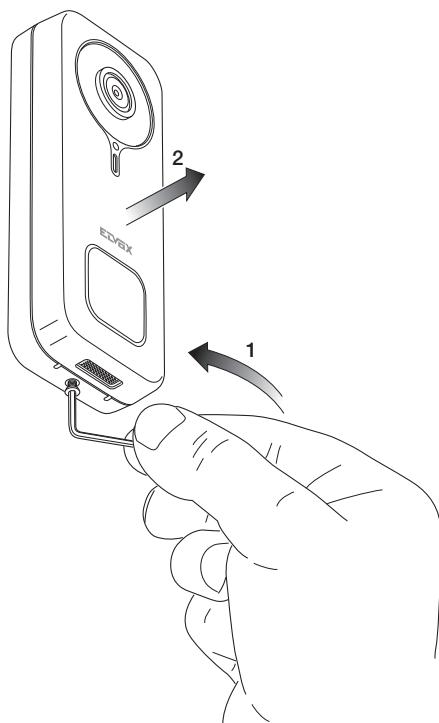

App: Connection

- 1) In order to be connected to the VIEW Door App, the device requires a MyVimar account. If the account is not available, create one at the link:
<https://www.vimar.com/en/int/user/login>
(The account can be created both on the web and using the app).
- 2) During the configuration process, the device will signal the configuration status using the colours of the status LEDs and voice messages (only in English)
The voice messages should be considered a configuration aid
- 3) The first time you turn it on:
 - you will hear the following voice message: "Please use your mobile for Wi-Fi configuration"
 - the status LED will be static blue (7s)
- 4) Make sure your mobile phone is connected to the Wi-Fi network you wish to connect the device to

- 5) Activate the App: the App will display the page shown below (Fig.1):

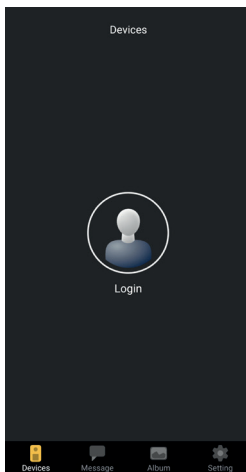

Fig. 1

- 6) Tap on "Login": the page shown Fig.2 will be displayed.

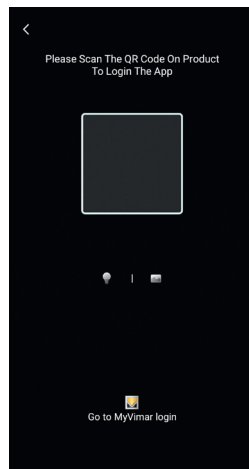

Fig. 2

K40960 - K40965

7) Tap on the bottom (“Go to MyVimar login”) to go to the account login page Fig.3. If you don't have a MyVimar account yet, create it by tapping on the link “Want to create a profile? Do you want to manage your profile?” which takes you to the MyVimar website



Fig. 3

8) Once you have logged into your account, the “Devices” page is displayed, as shown in Fig.4:

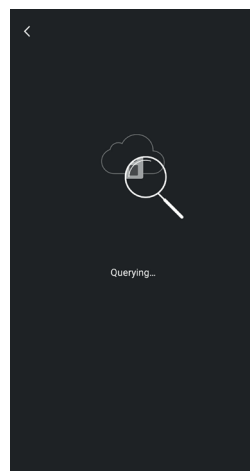

Fig. 4

9) To connect the device, touch the central icon “+”, to go to the page shown in Fig.5. As you can see in the image, the device can be identified in three ways:

- a. By scanning the QR code on the label on the back, point (18)
- b. By searching the local network (LAN, for use with devices previously connected to the Wi-Fi network),
- c. Via manual configuration, using the data shown on the label on the back of the Wi-Fi video doorbell.

In each of the above cases, the App will prompt the user with the steps to follow.

10) Below is an illustration of the configuration of a smart Wi-Fi video doorbell by scanning the QR code (case a).

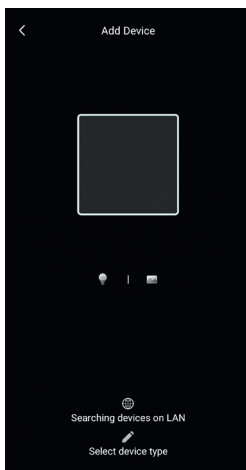

Fig. 5

Scan the QR code: the App will recognise the code and the page shown in Fig.6 will be displayed

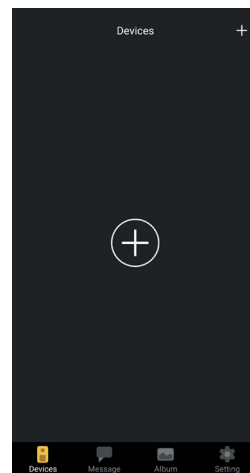

Fig. 6

K40960 - K40965

- 11) The first time it is installed, the device is already reset and ready for configuration: you can therefore move on to point 12) and confirm the reset.

In general, in installations subsequent to the first one: the page shown in Fig.7 is not displayed, reset the device by inserting the reset key in the hole shown in point (15) and long press until you hear an acoustic confirmation tone.

As soon as the device has completed the reset process, you will hear the message "Reset success"

- 12) Confirm the reset on the page shown in Fig.7

- 13) After reset confirmation, you will hear the voice message: "Please use your mobile phone for Wi-Fi configuration"

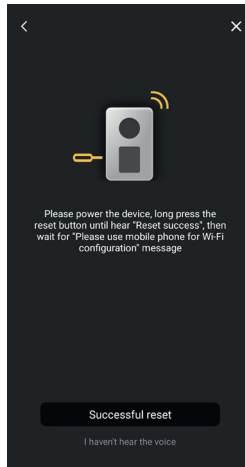

Fig. 7

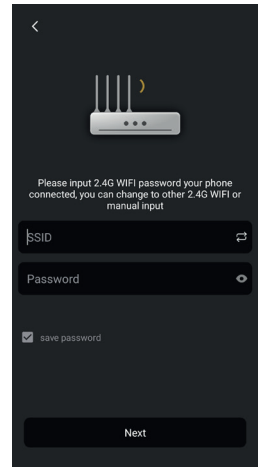

Fig. 8

- 14) Subsequently, the App will request the data relating to the Wi-Fi network you wish to connect the device.

After checking whether the SSID of the Wi-Fi network you wish to connect the Wi-Fi video doorbell to is selected and that the related password has been entered, as shown in Fig. 8, make sure you tap on the next push button,

- 15) The App will search for the device and request confirmation and any authorisations to connect to the device whose UID begins with ODS, as shown in Fig. 9.

Depending on the Operating System used, the App may request specific authorisations, as indicated further in the paragraph entitled "VIEW Door App: Permissions".

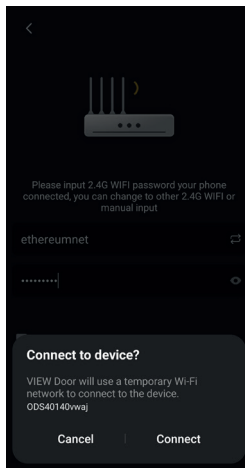

Fig. 9

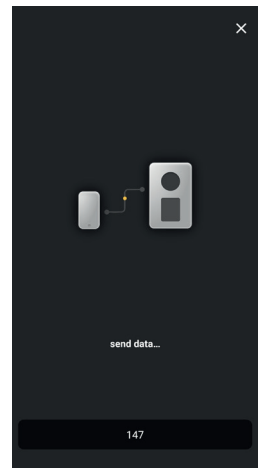

Fig. 10

K40960 - K40965

16) Once you have authorised the connection, you will hear the voice message "Please wait for internet connecting" and the page shown in fig. 10 will be displayed.

17) Once the connection is established between the App and the doorbell, the App will display the page shown in Fig. 11.

18) Once you have set the name identifying the Wi-Fi video doorbell, save the settings by tapping on "Save".

When saving is complete:

- the device will emit a voice message: "Internet connected, welcome to use your doorbell"
- the doorbell status LED will become "static white" (S1).

19) In addition to the name, the App will ask you to define a device password (numerical password) as shown in Fig.12

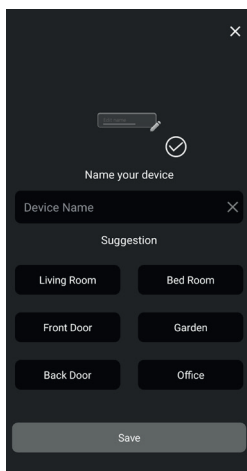

Fig. 11

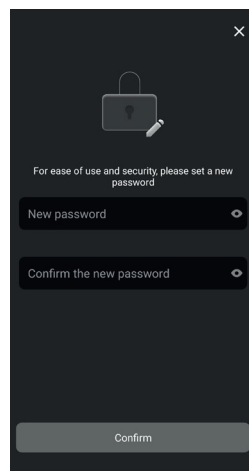

Fig. 12

Once the device password has been defined correctly, press "OK".

20) At the end of the configuration process, the device will appear in the "Devices" section, as shown in Fig.13.

Fig. 14 shows a video consultation example (self-start).

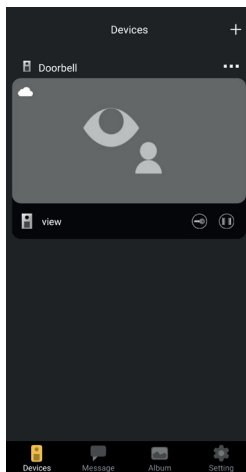

Fig. 13

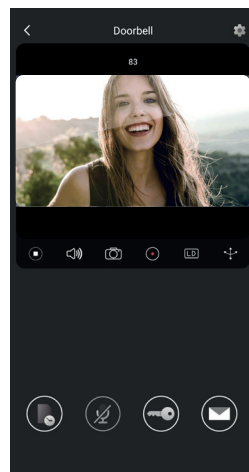

Fig. 14

VIEW Door App

The App comprises four sections:

- Devices: including the devices connected to the App
- Messages: including the notifications received
- Album: including videos and photos relating to the communications.
- Settings: data regarding the main settings and functions of the App.

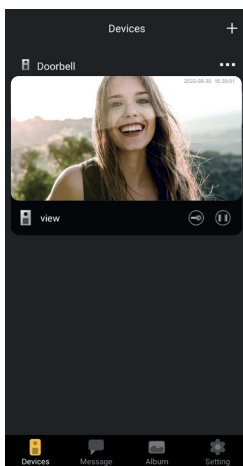

Devices

Each device connected to the App is distinguished by a name and a picture relating to the last communication as described below.



Please also note in the top left corner, of each picture, an icon is visible showing the status of the device.

The icons, for the device status, are:







| | |
|--|--|
|  | <p>the icon indicates that the device is on-line (and therefore connected to the cloud). The crossed-out icon indicates that the device is off-line (If the device is off-line, calls and notifications cannot be communicated to the App).</p> |
|  | <p>The icon indicates that the App and Wi-Fi video doorbell are only connected via Wi-Fi without connection to the cloud. N.B.: in this situation, the Wi-Fi video doorbell can be consulted (and so the settings and recordings can be consulted) but any calls and notifications cannot be communicated to the App).</p> |
|  | <p>The icon indicates that the device password entry will be requested, for safety reasons, at the first activation of the lock or relay.</p> |

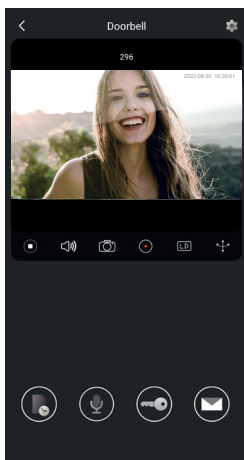



K40960 - K40965

By tapping on the picture, the video preview mode is activate and the pictures related to the activated device appear on the App.

In general, in preview mode, the App will be as shown in the picture below:

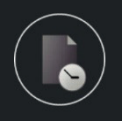
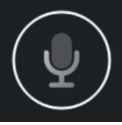

| | |
|--|---|
|  | Play / Stop key: activation / deactivation of video mode or deactivation of audio-video communication |
|  | Activation / deactivation of audio reception from device (to the smartphone speaker) |
|  | Still capture |
|  | Record video |
|  | Video picture resolution selection (HD: 2560 x 1440 px / SD: 1280 x 720 px/ LD: 640 x 384 px) |
|  | Video image rotation |

| | |
|--|--|
|  | Consult pictures / videos saved |
|  | Activation / Deactivation of smartphone microphone |
|  | Lock: lock activation |
|  | Customised voice messages |
|  | Setting: Wi-Fi video doorbell settings |

Messages

Contains the list of all the notifications sent from the devices connected to the App, with search filters by device, type of event and date.

From each item on the list, you can access the related recording, where available, for consulting and possible exporting in standard format (mp4 or jpg) for filing

Album





Contains the videos and photos taken during the communications and saved in the internal memory of the smart Wi-Fi video doorbell, with search filters by device, type (picture or video) and date.



During consultation of a specific recording, you can download the recording in the phone's memory in standard format (mp4 or jpg) for filing.

Settings







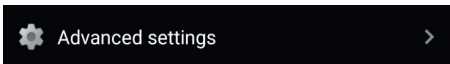
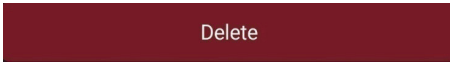





Used to configure some features of the connected device.

VIEW Door App: Wi-Fi video doorbell settings menu

| | |
|--|---|
|  | <p>Used to access the Wi-Fi video doorbell settings. Below are the settings and related descriptions.</p> |
|  | <p>Used to change the name of the Wi-Fi video doorbell.</p> |
|  | <p>Used to display detailed information about the device, such as the UID (unequivocal identification) / Model / Fw version and availability of possible fw updates.</p> |
|  | <p>Used to: activate/deactivate the video; format the SD card for encrypted recording of videos and pictures, checking the size of the sd-card inserted and the space occupied by the recordings. Should the space on the sd-card be used up completely, the new recordings will be saved by deleting those which are oldest in chronological order; what's more the SD card is reformatted every time the device is reset. We recommend you export and save onto other media any pictures and videos you wish to keep. In this section, you can also record customised voice messages.</p> |
|  | <p>The MyVimar user who first configures the device obtains complete control of it as its administrator. They may share the use of the device with other MyVimar users by search for the e-mail address or sending a dedicated QR code or link. Users to whom use has been shared have access to a limited set of configurations. The administrator user may revoke access individually from each user invited. To revoke the administrator user, the device needs to be reset.</p> |

| | |
|---|--|
|  | <p>The sending by the device of notifications following specific events can be activated. These events are:</p> <ol style="list-style-type: none"> 1) Motion detection (in other words a generic variation in the picture taken by the video doorbell). Specific motion detection areas can be defined within a default grid. All the areas are active by default. N.B.: the selection of the area in which motion detection is active is represented by a slight darkening of the area itself. 2) Human presence detection (the Wi-Fi video doorbell signals the present of humans). Detection is performed on the entire picture. 3) Call alert Tampering with the device (detachment from the bracket with device powered) N.B.: human presence detection, in specific light conditions, may be subject to false positives and/or false negatives. |
|  | <p>Menu for activating:</p> <ol style="list-style-type: none"> 1) Motion detection, defining <ol style="list-style-type: none"> a. (within a 4 x 4 grid) customised detection areas. b. Motion sensitivity. c. Setting according to time bands d. Recording activation following motion detection 2) Human detection, defining: <ol style="list-style-type: none"> a. Detection sensitivity b. Setting according to time bands c. Recording activation following human presence detection 3) Call detection <ol style="list-style-type: none"> a. Setting according to time bands b. Recording activation following call detection |
|  | <p>Menu for Advanced settings: (see below)</p> |
|  | <p>Push button to remove the doorbell connection to the App. N.B.: the doorbell remains configured and connected to the Wi-Fi network."</p> |

VIEW Door App: Menu for Advanced Settings

| <p>Change Password ></p> | <p>Menu for device password update.</p> | | | | | | | | | | | | | | | |
|-----------------------------------|--|---|-------|------|--------------|------|---|------------|--------|---|------------|------|---|--------------|------|---|
| <p>Unlocking remain time ></p> | <p>Menu for: 1) Setting the current to keep the lock powered (Lock1) 2) Setting the relay activation time (Lock2)</p> | | | | | | | | | | | | | | | |
| <p>Wi-Fi Switch ></p> | <p>Menu for controlling the radio signal intensity of the network to which the device is connected and to change to a different Wi-Fi network. The device works correctly with a Wi-Fi signal of appropriate intensity: we advise against using the device when the Wi-Fi signal is weak or poor intensity. The recommended range of values is shown in the following picture:</p> <table border="1" data-bbox="703 660 885 895"> <thead> <tr> <th>level</th> <th>label</th> <th>icon</th> </tr> </thead> <tbody> <tr> <td>above -50 dB</td> <td>good</td> <td></td> </tr> <tr> <td>-50/-60 dB</td> <td>medium</td> <td></td> </tr> <tr> <td>-60/-70 dB</td> <td>weak</td> <td></td> </tr> <tr> <td>below -70 dB</td> <td>poor</td> <td></td> </tr> </tbody> </table> | level | label | icon | above -50 dB | good |  | -50/-60 dB | medium |  | -60/-70 dB | weak |  | below -70 dB | poor |  |
| level | label | icon | | | | | | | | | | | | | | |
| above -50 dB | good |  | | | | | | | | | | | | | | |
| -50/-60 dB | medium |  | | | | | | | | | | | | | | |
| -60/-70 dB | weak |  | | | | | | | | | | | | | | |
| below -70 dB | poor |  | | | | | | | | | | | | | | |
| <p>Shortcut Setting ></p> | <p>Menu for activating direct controls, for display, lock activation and relay activation.</p> | | | | | | | | | | | | | | | |
| <p>Thumbnails Setting ></p> | <p>Possibility of default video image customisation.</p> | | | | | | | | | | | | | | | |
| <p>Sound Setting ></p> | <p>Menu which can be used to set: 1) Conversation audio volume 2) Call tone volume</p> | | | | | | | | | | | | | | | |
| <p>Preview time 300s ></p> | <p>Menu for setting the maximum time of a communication or preview with App.</p> | | | | | | | | | | | | | | | |
| <p>Synchronization time zone</p> | <p>Menu for synchronising the device time according to the time zone in which the smartphone is located.</p> | | | | | | | | | | | | | | | |

VIEW Door App: Permissions

For the App to function correctly, make sure that the permissions required have been enabled.

For the Android system permission must be given for:

- Camera
- Memory (file and media)
- Location
- Microphone
- Nearby devices
- Edit/write system settings (at least in Android 6)

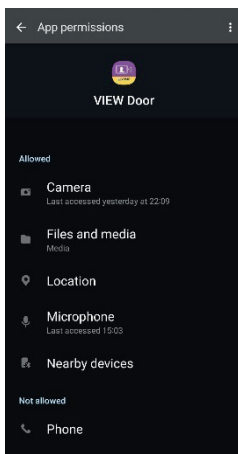

Also make sure you ensure the Battery Management on your smartphone allows the correct functioning of the App in background without interruptions.

Wi-Fi video doorbell – Amazon Alexa: integration

The Wi-Fi video doorbell can interact with the Amazon Alexa voice assistant.

To activate the integration, simply activate the “Vimar VIEW Door” skill from the Amazon Alexa App.

The skill will therefore allow you to receive call alerts in the Echo family of devices.

Audio-video interaction will be possible in Echo Show devices.

Audio interaction will be possible only in the Echo, Echo Flex, Echo dot, Echo Studio devices.

N.B.:

If you activate the Vimar VIEW Door skill, you will also be able to control two locks (powered lock and relay).

Please note that lock enabling via the Amazon Alexa App should be carried out by the end user.

The vocal control of a lock, for safety reasons, is protected by a 4-digit safety PIN.

Please keep this code confidential, to avoid unauthorised people activating it.

We specifically advise against using the vocal release control during communication with the Wi-Fi video doorbell, since the code may be heard outside.

Amazon, Alexa and all related logos are trademarks of Amazon.com, Inc. or its affiliates.
Amazon, Alexa and all related logos are trademarks of Amazon.com, Inc. or its affiliates.

K40960 - K40965

Wi-Fi video doorbell- App: Call

Call sequence from Wi-Fi video doorbell - answering via the App:

1) Call from doorbell:

2) Call alert on your smartphone, (Fig. 21).

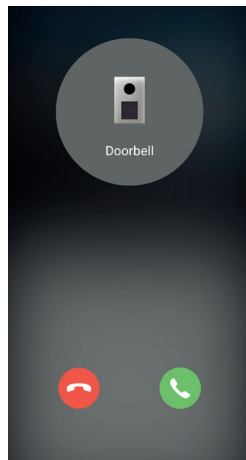

Fig. 21

3) After the call is accepted, the preview is activated, (Fig 22):

4) Upon activation of the microphone, two-way audio communication is activated.

5) To end only the audio communication, tap on



the microphone icon

To end the audio communication and the image filmed, tap on the Play / Stop icon



To exit the page, tap on

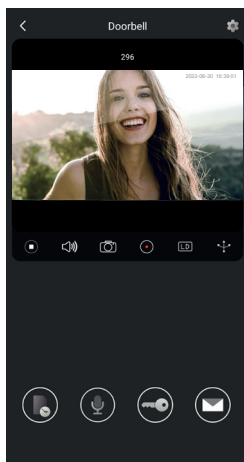

Fig. 22

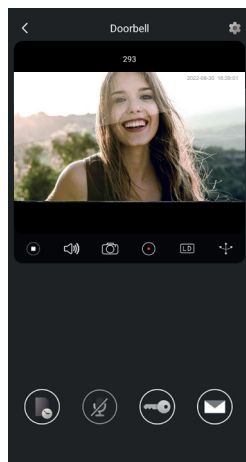
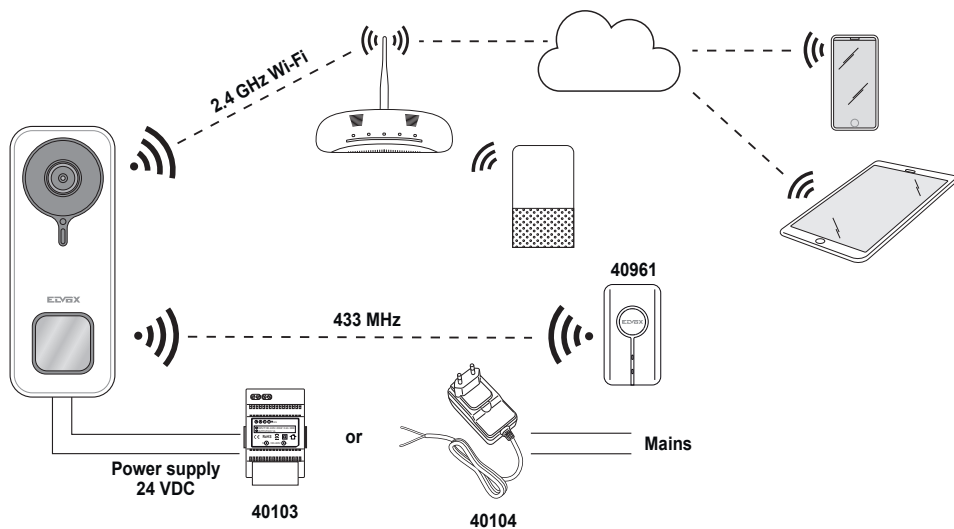

Fig. 23

N.B.: if the Wi-Fi video doorbell is connected to several Apps, consultation of a device in communication will have "device busy" as its answer.

Wiring diagram



K40960 - K40965

Information notes

Product K40960 - K40965 (Wi-Fi video doorbell kit) is a "smart" video door entry system and can therefore be used in compliance with and for the purposes envisaged by the instructions herein. Vimar shall not be liable in any manner whatsoever for other uses or for uses which do not comply with the laws and regulations in force.

For this purpose, if the device is used in any method or for any purpose other than its intended use, the user shall comply with the provisions of Regulation (EU) 2016/679 on the protection of personal data.



- Installation must be carried out by qualified persons in compliance with the current regulations regarding the installation of electrical equipment in the country where the products are installed.

Regulatory compliance

RED Directive, RoHS directive.

Standards EN 301 489-3, EN 301 489-17, EN 300 328, EN 300 220-2, EN 55032, EN 55035, EN IEC 61000-3-2, EN 61000-3-3, EN 62368-1, EN IEC 62311, EN IEC 63000.

REACH (EU) Regulation no. 1907/2006 – art.33 The product may contain traces of lead.

Vimar SpA declares that the radio equipment complies with Directive 2014/53/EU. The full text of the EU declaration of conformity is on the product sheet available at the following Internet address: www.vimar.com.



- **WEEE - User information.** The crossed bin symbol on the appliance or on its packaging indicates that the product at the end of its life must be collected separately from other waste. The user must therefore hand the equipment at the end of its life cycle over to the appropriate municipal centres for the differentiated collection of electrical and electronic waste. As an alternative to independent management, you can deliver the equipment you want to dispose of free of charge to the distributor when purchasing a new appliance of an equivalent type. You can also deliver electronic products to be disposed of that are smaller than 25 cm for free, with no obligation to purchase, to electronics distributors with a sales area of at least 400 m². Proper sorted waste collection for subsequent recycling, processing and environmentally conscious disposal of the old equipment helps to prevent any possible negative impact on the environment and human health while promoting the practice of reusing and/or recycling materials used in manufacture.

- For further information visit www.vimar.com



MU_EN_K40690_K40695 01 2209



VIMAR

Viale Vicenza 14
36063 Marostica VI - Italy
www.vimar.com